

NEY Product Information



Data Sheet

Mini Cabinet

Sliding Door System



NEY Ltd (Head Office)
Stonebridge Trading Estate
Sibree Road
Coventry
CV3 4FD

t 024 7630 8100
f 024 7630 8101
e sales@ney.co.uk

NEY Ireland
Unit 22 Blaris Ind Estate
Altona Road
Lisburn
BT27 5QB

t 028 92 673 000
f 028 92 672 999
e ireland@ney.co.uk

NEY Scotland
Block 2 Units 1-2-3
Bandeath Ind Est
Throsk, Stirling
FK7 7NP

t 01786 814 814
f 01786 814 812
e scotland@ney.co.uk



Applications

- Kitchen cupboards.
- Bathroom cabinets.

Features

- Bottom running system.
- Easily installed and durable.
- Quiet sliding action.
- High quality aluminium profiles.
- Max. Load per leaf - 15kg.
- Overlapping sliding door (inset only).
- Ball bearing with silencing tyres.
- Surface mounting hardware.
- Adjustable upper / lower travel hardware.



Ball Bearing



15Kg



16/18mm
Board



Natural



MINI CABINET
Sliding door system

MINI CABINET System overview

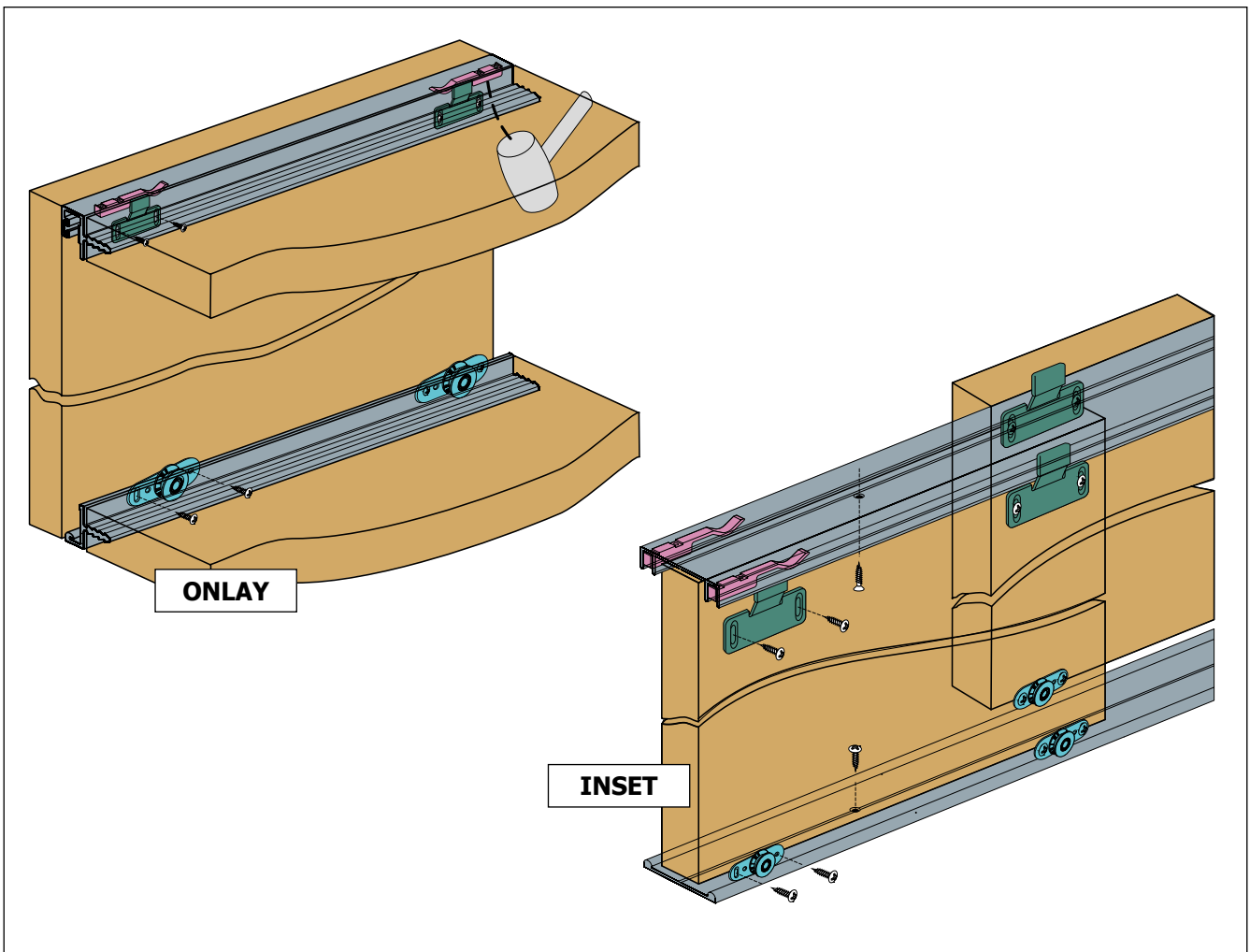

Kit contents for 1 x door

LA000008 1 Door

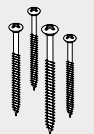

Screw kit

(x1)

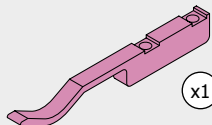

(x1)

LA000004
End catch

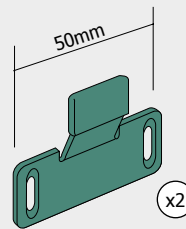

(x2)

LA000002
Upper travel hardware

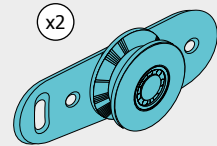

(x2)

LA000006
Lower travel hardware

Accessories

Optional guide rails for onlay door / single track system only.

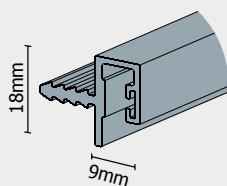

LA001565
Upper guide rail

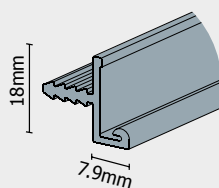

LA001566
Lower guide rail

Essentials

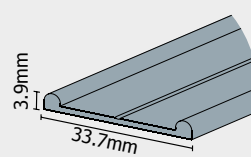

LA001563
Lower guide rail

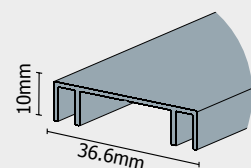

LA001564
Upper guide rail